

**YAMAHA Hi-Fi STEREO**

**PARTS LIST**

**NS-1000 SERIES**

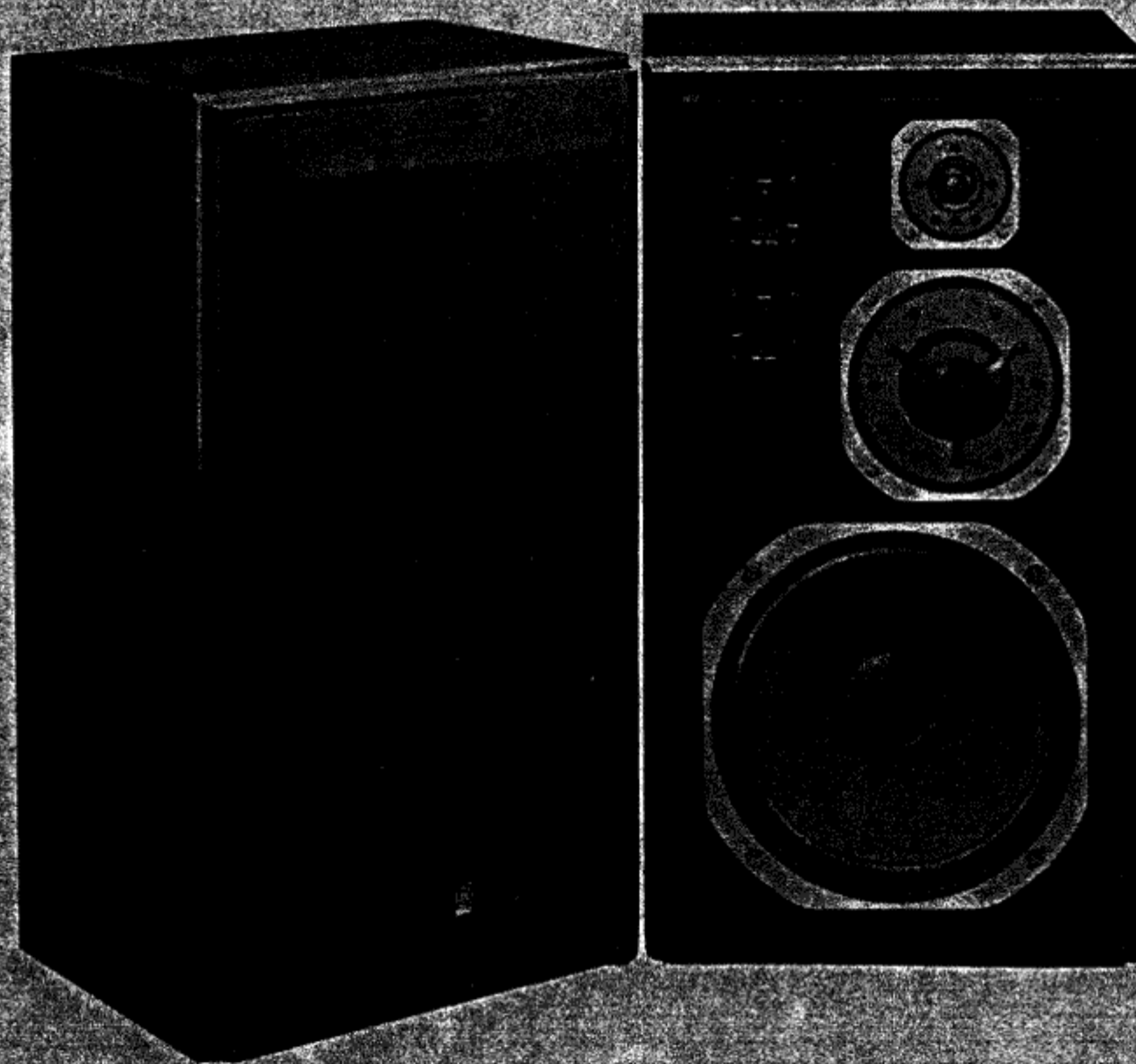

 **YAMAHA**

APL-40

① ⑤ Printed in Japan

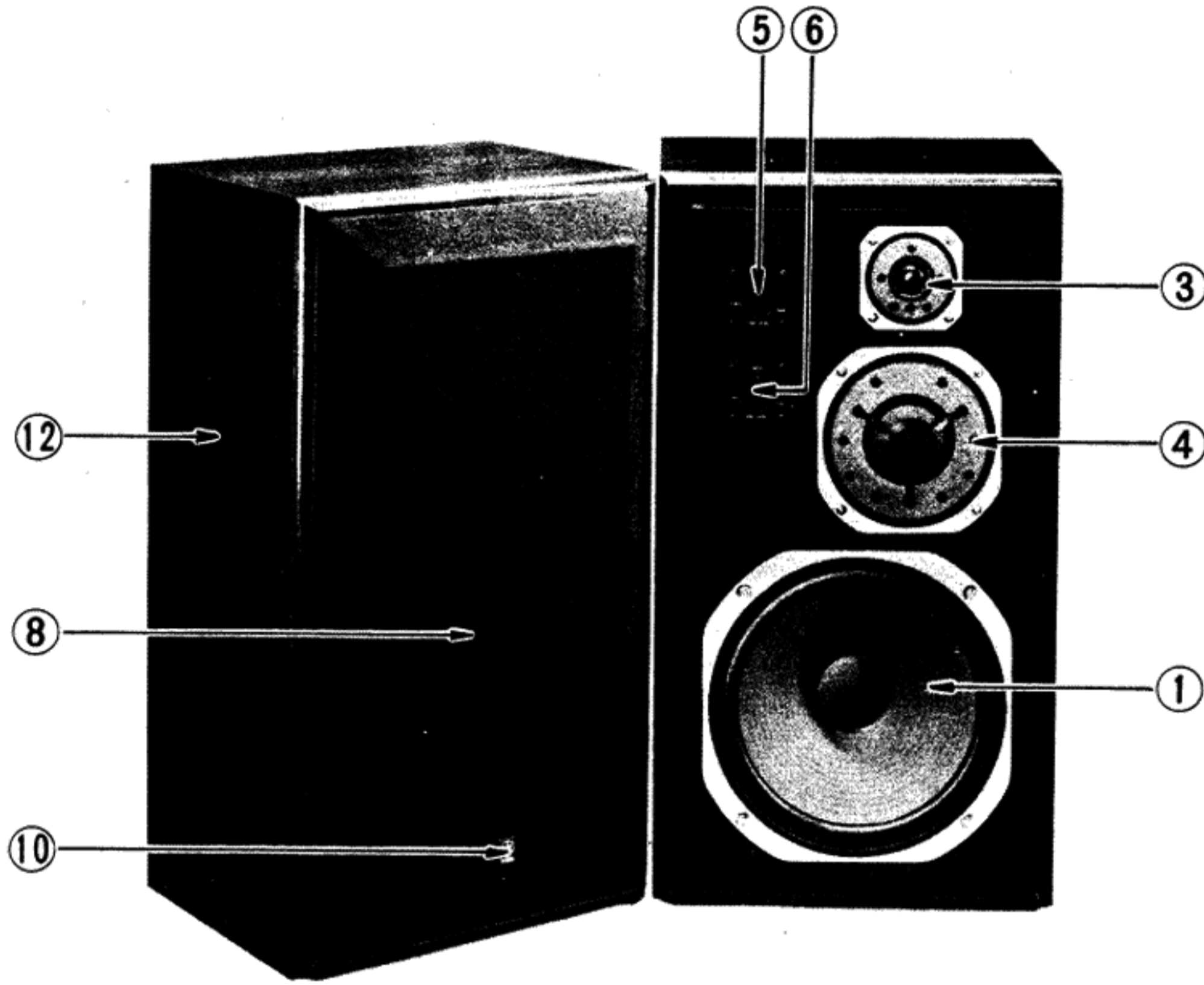

NS-1000

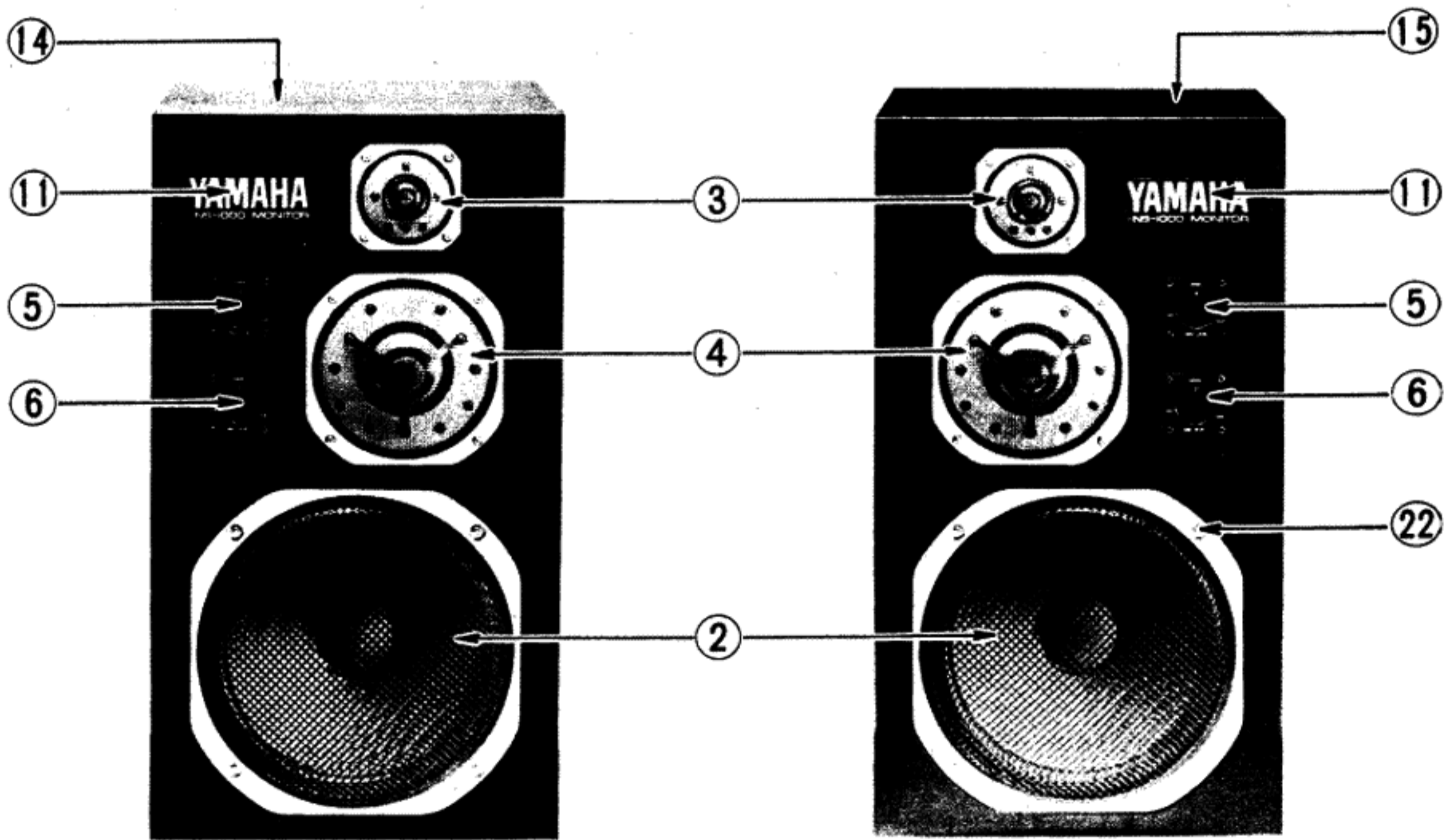

NS-1000M

NS-1000 SERIES

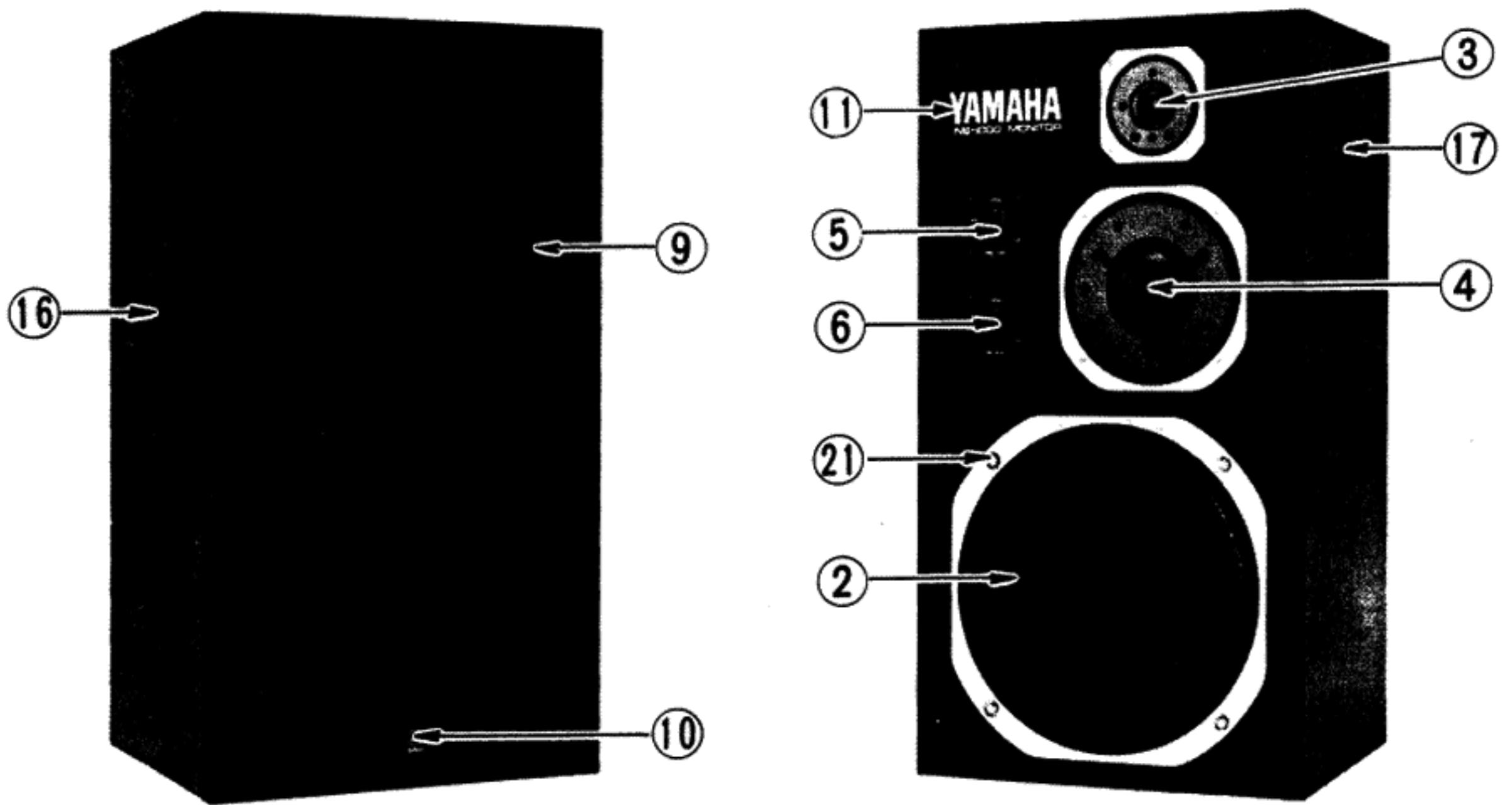

NS-1000MS

NET-WORK ASSEMBLY

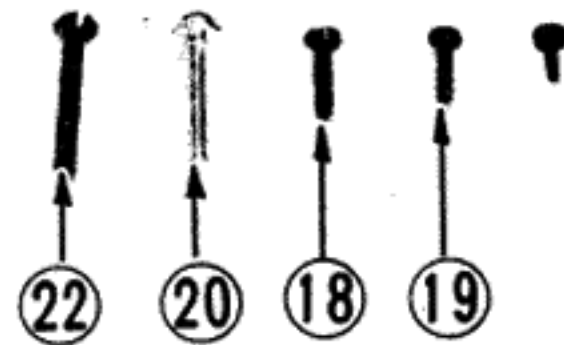
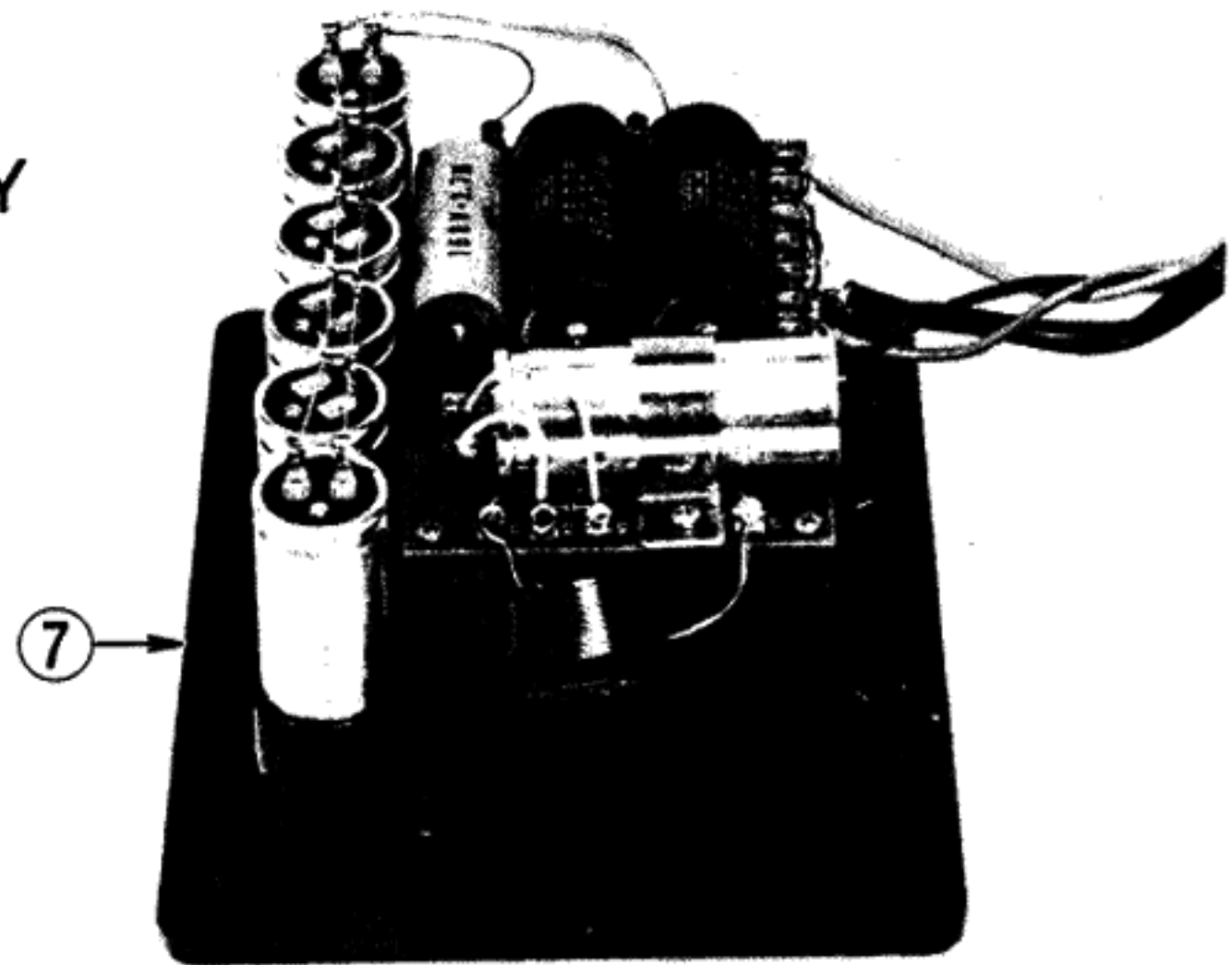

Schematic Diagram

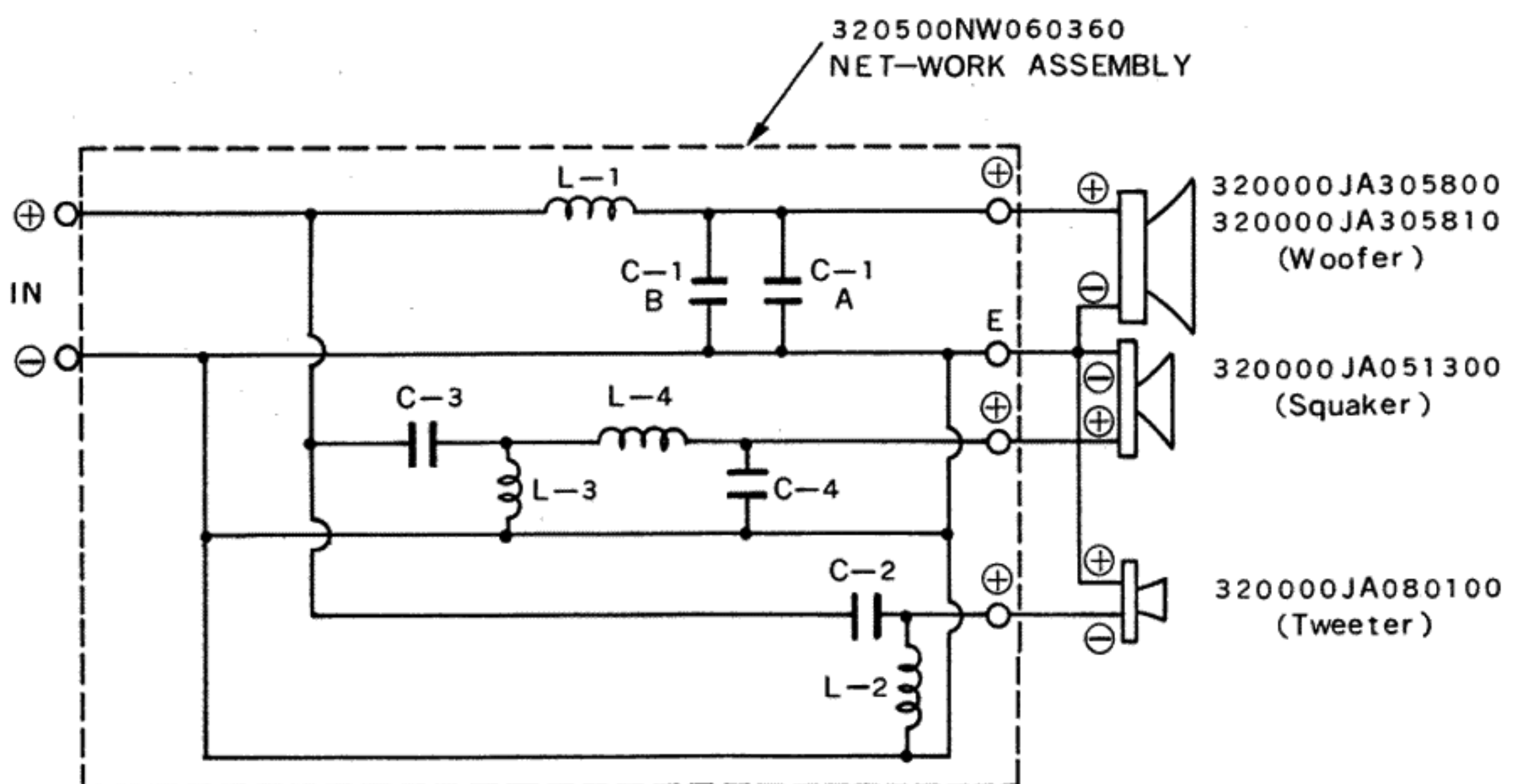

NS-1000 SERIES

Ref. No.	Part No.	Description		Remarks	Common Models	FOB Japan US \$
①	320000JA305800	Speaker (Woofers)	スピーカ ウーハー	NS-1000		
②	320000JA305810	-do.- (Woofers)	スピーカ ウーハー	NS-1000M, 1000MS		
③	320000JA080100	-do.- (Tweeter)	スピーカ ツイーター	NS-1000, 1000M, 1000MS		
④	320000JA051300	-do.- (Squaker)	スピーカ スクォーカー	-do.-		
⑤	320575NB071950	Level Control Assembly (High)	レベルコントロール アッセンブリー	-do.-		
⑥	320575NW071960	-do.- (Middle)	"	-do.-		
⑦	320500NW060360	Net - Work Assembly	ネットワーク アッセンブリー	-do.-		
⑧	32057600031000	Front Panel	前板サラン張り	NS-1000		
⑨	32057500031000	-do.-	"	NS-1000MS		
	320000CB074910	Ratch	ラ ッ チ	NS-1000MS		
⑩	320000BA066960	Audio-Emblem	オーディオ エンブレム	NS-1000, 1000MS		
	420000CB069610	Strike	ストライク	NS-1000MS		
	420000CB069620	Support	サポ ー ト	-do.-		
⑪	420000CB072770	Lavel	ラ ベ ル	NS-1000M, 1000MS		
	420000LA000860	Push Terminal 2PD	2PD型 プッシュターミナル	NS-1000, 1000M, 1000MS		
	320500MZ064420	Speaker cord	S P コ ー ド	NS-1000, 1000M, 1000MS		
⑫	32057685040001	Wooden Cabinet ,Left	外 装	NS-1000		
⑬	32057685040000	" ,Right	"	-do.-		
⑭	32057508040001	" ,Left	"	NS-1000M		
⑮	32057508040000	" ,Right	"	-do.-		
⑯	32057508609220	" ,Left	"	NS-1000MS		
⑰	32057508609221	" ,Right	"	-do.-		
⑱	420000ER235200	Flat Head Screw 3.5 x 20 (ZMC2 - BL)	丸皿木ネジ	NS-1000, 1000M, 1000MS (Net Work)		
⑲	420000ER231160	-do.- 3.1 x 16 (-do.-)	"	-do.- (Level Control)		
㉑	420000EZ000170	SEMS Screw M4 x 30 (FNM3 x 3g)	ナベ小ネジ	-do.- (Tweeter & Squaker)		
㉒	420000EZ000300	-do.- M6 x 30 (-do.-)	"	-do.- (Woofers)		
㉓	420000EP341400	Flat Head Screw 4.1 x 40 (ZMC - BL)	鉄皿木ネジ	-do.- (Back Board)		